

HS-3000/4M

386 ISA Bus SBC

- CRT/Panel • RS-232/422/485 • 4 COM •
- PC/104 • DOC • WDT • Single +5V •

ISA Bus Industrial Single Board Computer

Copyright Disclaimers

The accuracy of contents in this manual has passed thorough checking and review before publishing. BOSER Technology Co., Ltd., the manufacturer and publisher, is not liable for any infringements of patents or other rights resulting from its use. The manufacturer will not be responsible for any direct, indirect, special, incidental or consequential damages arising from the use of this product or documentation, even if advised of the possibility of such damage(s).

This manual is copyrighted and BOSER Technology Co., Ltd. reserves all documentation rights. Unauthorized reproduction, transmission, translation, and storage of any form and means (i.e., electronic, mechanical, photocopying, recording) of this document, in whole or partly, is prohibited, unless granted permission by BOSER Technology Co., Ltd.

BOSER Technology Co., Ltd. reserves the right to change or improve the contents of this document without due notice. BOSER Technology Co., Ltd. assumes no responsibility for any errors or omissions that may appear in this manual, nor does it make any commitment to update the information contained herein.

Trademarks

BOSER is a registered trademark of BOSER Technology Co., Ltd.

ISB is a registered trademark of BOSER Technology Co., Ltd.

Intel is a registered trademark of Intel Corporation.

Award is a registered trademark of Award Software, Inc.

AMI is a registered trademark of AMI Software, Inc.

All other trademarks, products and or product names mentioned herein are mentioned for identification purposes only, and may be trademarks and/or registered trademarks of their respective companies or owners.



**© Copyright 2004 BOSER Technology Co., Ltd.
All Rights Reserved.
Edition 1.6 August 05, 2004**

Table of Contents

Chapter 1	General Description.....	1
1.1	Major Features	2
1.2	Specifications	3
1.3	Board Dimensions	4
Chapter 2	Unpacking	5
2.1	Opening the Delivery Package.....	5
2.2	Inspection.....	5
Chapter 3	Hardware Installation	7
3.1	Before Installation	7
3.2	Board Layout	8
3.3	Jumper List	9
3.4	Connector List	9
3.5	DiskOnChip™ Address Setting	10
3.6	Watchdog Timer	10
3.7	VGA Controller.....	12
3.8	Serial Port Connectors	17
3.9	Keyboard & Mouse Connector.....	18
3.10	Speaker Connector	19
3.11	PCI E-IDE Drive Connector	20
3.12	Parallel Connector.....	21
3.13	Power and LED Connectors	21
3.14	Floppy Disk Drive Connector	22
3.15	Flash ROM Type	23
3.16	System Memory	23
3.17	PC/104 Bus Connection.....	23

Chapter 4	AMI BIOS Setup.....	27
4.1	Starting Setup	27
4.2	Using Setup.....	28
4.3	Main Menu	29
4.4	Standard CMOS Setup	30
4.5	Advanced CMOS Setup	31
4.6	Advanced Chipset Setup	32
4.7	PCI / Plug And Play Setup	33
4.8	Peripheral Setup	34
4.9	Auto-Detect Hard Disks	35
4.10	Change Supervisor/User Password	36
4.11	Auto Configuration with Optimal Settings.....	37
4.12	Auto Configuration with Fail Safe Settings	38
4.13	Save Settings and Exit.....	39
4.14	Exit Without Saving.....	40

Safety Instructions

Integrated circuits on computer boards are sensitive to static electricity. To avoid damaging chips from electrostatic discharge, observe the following precautions:

- Do not remove boards or integrated circuits from their anti-static packaging until you are ready to install them.
- Before handling a board or integrated circuit, touch an unpainted portion of the system unit chassis for a few seconds. This helps to discharge any static electricity on your body.
- Wear a wrist-grounding strap, available from most electronic component stores, when handling boards and components. Fasten the ALLIGATOR clip of the strap to the end of the shielded wire lead from a grounded object. Please wear and connect the strap before handle the HS-3000/4M to ensure harmlessly discharge any static electricity through the strap.
- Please use an anti-static pad when putting down any components or parts or tools outside the computer. You may also use an anti-static bag instead of the pad. Please inquire from your local supplier for additional assistance in finding the necessary anti-static gadgets.

NOTE: *DO NOT TOUCH THE BOARD OR ANY OTHER SENSITIVE COMPONENTS WITHOUT ALL NECESSARY ANTI-STATIC PROTECTION.*

This page is intentionally left blank.

Chapter 1

General Description

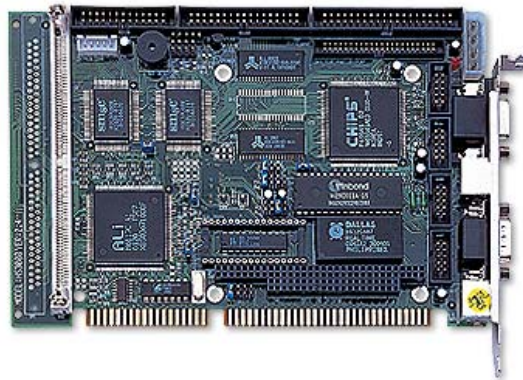

The HS-3000/4M is ISA Bus ALI M6117C chipset industrial single board computer. The board design combine together with all necessary input and output effects interfaces which makes it an ideal all-in-one industrial single board computer. The board design with 40MHz Bus clock rate architecture. The HS-3000/4M supports one SIMM socket with a max. capacity of 16MB and 4MB RAM onboard.

The IDE interface with LBA mode access to IDE drive interface architecture, supports with max. 11MB/sec in a data transfers rating to two IDE drive connection. One set of PC/104 Bus connector for 16-bit ISA Bus.

A single Flash chip holds the system BIOS, and you can change the Flash BIOS by the Utility Update. You can also use the DOS version of the "DiskOnChip" socket by issuing commands from the DOS prompt without the necessity of other software supports up to 288MB.

The board design with 65545 CRT/Panel display controller provides internal connections to CRT or Panel. The VGA provides up to 1024 x 768 x 16 colors resolution.

If a non-expected program cause halts, the onboard Watchdog Timer (WDT) will automatically reset the CPU or generate an interrupt. The WDT is designed with pure hardware and doesn't need any arithmetical functions of a real-time clock chip. This ensures the reliability in an unmanned or standalone system.

1.1 Major Features

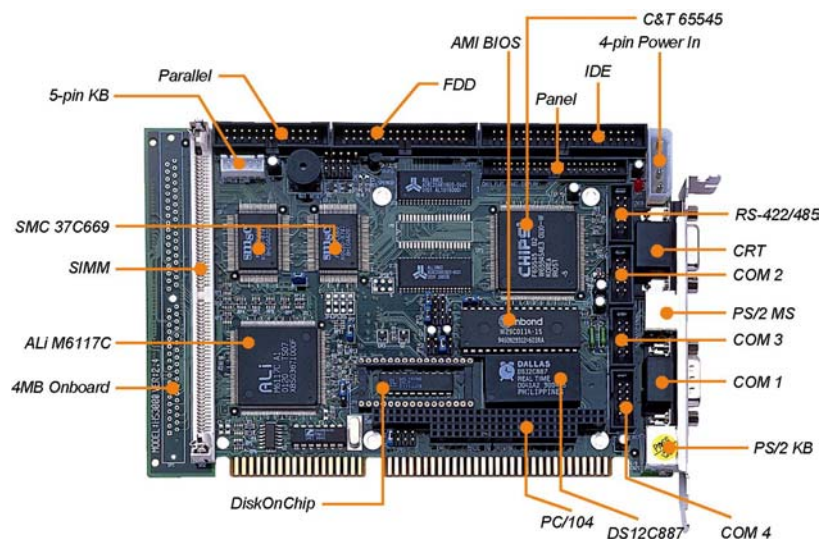

The HS-3000/4M comes with the following features:

- Intel® 386SX compatible CPU
- One SIMM socket with a max. capacity of 16MB and 4MB RAM onboard
- ALi M6117C system chipset
- SMC 37C669 super I/O chipset
- C&T 65545 CRT/Panel display controller
- Four COM connectors
- PC/104 Bus connector
- DiskOnChip™ socket supporting memory sizes of up to 288MB
- Single +5V power in

1.2 Specifications

- **CPU:** 386SX-40 embedded in ALi M6117C chipset
- **Bus Interface:** ISA Bus
- **Memory:** One SIMM socket with a max. capacity of 16MB and 4MB RAM onboard
- **Chipset:** ALi M6117C
- **I/O Chipset:** SMC 37C669 x 2
- **VGA:** C&T 65545 with 1MB memory supporting CRT/Panel displays up to 1024 x 768 at 16 colors
- **IDE:** Two IDE disk drives supporting LBA mode and with a transfer rate of 11MB/sec.
- **FDD:** Supports up to two floppy disk drives
- **Parallel:** One enhanced bi-directional parallel port supporting SPP/ECP/EPP
- **Serial Port:** 16C550 UART-compatible RS-232/422/485 x 1 and RS-232 x 3 serial ports with 16-byte FIFO
- **PC/104:** PC/104 connector for 16-bit ISA Bus
- **Keyboard:** PS/2 6-pin Mini DIN or 5-pin connector
- **Mouse:** PS/2 6-pin Mini DIN
- **DiskOnChip™:** DiskOnChip™ socket supporting memory sizes of up to 288MB
- **BIOS:** AMI PnP Flash BIOS
- **Watchdog Timer:** Sets 1/2/10/20/110/220 seconds activity trigger with Reset or NMI
- **CMOS:** DS12C887 or equivalent device
- **Power:** Single +5V/1.8A power in
- **Power Connector:** One 4-pin +5V/+12V power connector
- **Temperature:** 0~60°C (operating)
- **Dimensions:** 18.6 x 12.2 cm

1.3 Board Dimensions

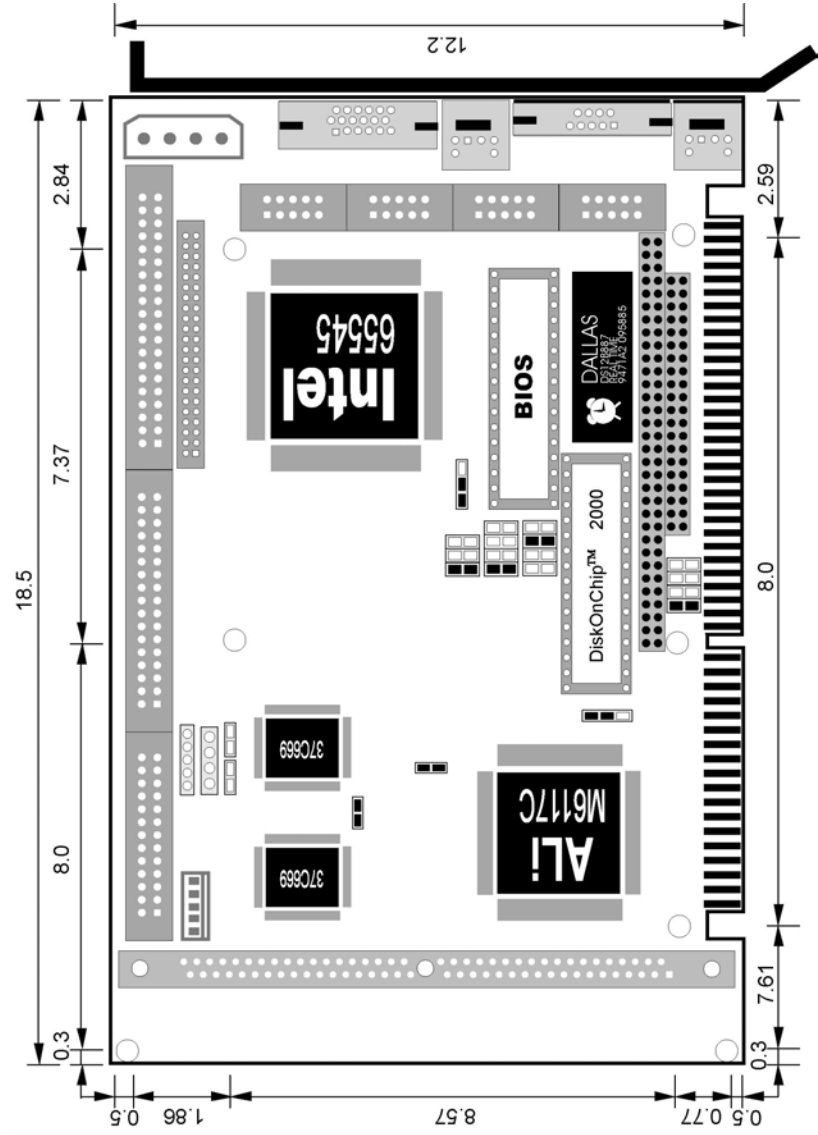

Chapter 2

Unpacking

This chapter explains unpacking the board, checking the equipment and documentation and where to go from there.

2.1 Opening the Delivery Package

The HS-3000/4M is packed in an anti-static bag. The board has components that are easily damaged by static electricity. Do not remove the anti-static wrapping until proper precautions have been taken. Safety Instructions in front of this manual describe anti-static precautions and procedures.

2.2 Inspection

After unpacking the board, place it on a raised surface and carefully inspect the board for any damage that might have occurred during shipment. Ground the board and exercise extreme care to prevent damage to the board from static electricity. Integrated circuits will sometimes come out of their sockets during shipment. Examine all integrated circuits, particularly the BIOS, processor, memory modules, ROM-Disk, and keyboard controller chip to ensure that they are firmly seated. The HS-3000/4M delivery package contains the following items:

- ◆ HS-3000/4M Board x 1
- ◆ IDE port flat cable x 1
- ◆ FDD port flat cable x 1
- ◆ Printer + one COM flat cable with bracket x 1
- ◆ Two COM flat cable with bracket x 1
- ◆ Utility CD Disk x 1
- ◆ User's Manual x 1

It is recommended that you keep all the parts of the delivery package intact and store them in a safe/dry place for any unforeseen event requiring the return shipment of the product. In case you discover any missing and/or damaged items from the list of items, please contact your dealer immediately.

Chapter 3

Hardware Installation

This chapter provides the information on how to install the hardware using the HS-3000/4M. This chapter also contains information related to jumper settings of switch, watchdog timer, and the DiskOnChip address selection etc.

3.1 Before Installation

After confirming your package contents, you are now ready to install your hardware. The following are important reminders and steps to take before you begin with your installation process.

1. Make sure that all jumper settings match their default settings and CMOS setup correctly. Refer to the sections on this chapter for the default settings of each jumper.
2. Go through the connections of all external devices and make sure that they are installed properly and configured correctly within the CMOS setup. Refer to the sections on this chapter for the detailed information on the connectors.
3. Keep the manual and diskette in good condition for future reference and use.

3.2 Board Layout

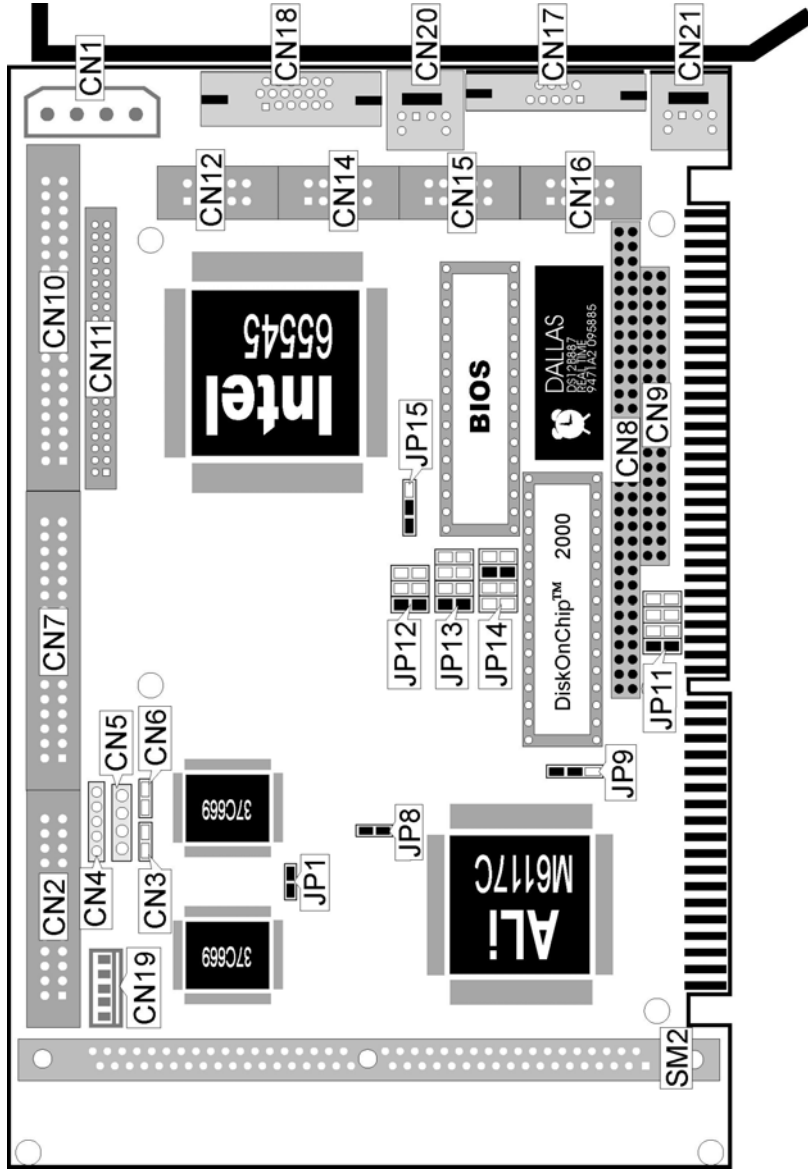

3.3 Jumper List

Jumper	Definition	Setting	Page
JP1	COM 4 Use RS-232 or RS-422/485 Select: <i>RS-232</i>	Open	17
JP8	IRQ12 Enabled/Disabled Select: <i>Enabled</i>	Short	18
JP9	WDT Active Type Select: <i>Reset System</i>	Short 1-2	10
JP11	DiskOnChip™ Address Select: <i>D000</i>	Short 1-2	10
JP12	RS-422/485 Receiver Enabled/Disabled Select: <i>Always Enabled</i>	Short 1-2	17
JP13	RS-422/485 Transmitter Enabled/Disabled Select: <i>Always Enabled</i>	Short 1-2	17
JP14	WDT Out Period Select: <i>1 sec.</i>	Short 5-6	10
JP15	Flash ROM Type Select: <i>29C010</i>	Short 1-2	23

3.4 Connector List

Connector	Definition	Page
CN1	4-pin Power Connector	21
CN2	Parallel Connector	21
CN3	Reset Button Connector	21
CN4	Keylock Connector	21
CN5	Speaker Connector	19
CN6	IDE LED Connector	21
CN7	Floppy Connector	22
CN8	PC/104 Bus 64-pin Connector	23
CN9	PC/104 Bus 40-pin Connector	23
CN10	IDE Connector	20
CN11	Panel Connector	12
CN12	RS-422/485 Connector	17
CN14	COM 2 Connector (5x2 header)	17
CN15	COM 3 Connector (5x2 header)	17
CN16	COM 4 Connector (5x2 header)	17
CN17	COM 1 Connector (DB9)	17
CN18	15-pin CRT Connector	12
CN19	5-pin Keyboard Connector	18
CN20	PS/2 6-pin Mini DIN Mouse Connector	18
CN21	PS/2 6-pin Mini DIN Keyboard Connector	18

3.5 DiskOnChip™ Address Setting

The DiskOnChip™ function allows the system to boot or operate without a FDD or a HDD. DiskOnChip™ modules may be formatted as drive C or A. With DiskOnChip™, user may also execute DOS commands such as FORMAT, SYS, COPY, XCOPY, DISCOPY and DISKCOMP etc.

The U9 location onboard the HS-3000/4M is the DiskOnChip module socket. Jumper JP11 assigns the address setting of the installed module. Setting the 8 pins of JP11 allows you to select the starting memory address of the DiskOnChip™ (D.O.C.). If you have additional memory devices in the system, please set both at different memory address mapping to avoid the mapping area conflicts.

- **JP11: DiskOnChip™ Address Select**

JP11	Address
Short 1-2 (default)	D000
Short 3-4	D800
Short 5-6	E000
Short 7-8	E800

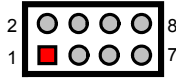

3.6 Watchdog Timer

There are three access cycles of watchdog timer as Enable, Refresh and Disable. The Enable cycle should proceed by READ PORT 443H. The Disable cycle should proceed by READ PORT 043H. A continue Enable cycle after a first Enable cycle means Refresh.

Once if the Enable cycle activity, a Refresh cycle is request before the time-out period for restart counting the WDT Timer's period. Otherwise, it will assume that the program operation is abnormal when the time counting over the period preset of WDT Timer. A System Reset signal to start again or a NMI cycle to the CPU comes if over.

The JP9 is using for select the active function of watchdog timer in disable the watchdog timer, or presetting the watchdog timer activity at the reset trigger, or presetting the watchdog timer activity at the NMI trigger.

● **JP9: Watchdog Timer Active Type Select**

JP9	Description
Short 1-2 (default)	System Reset
Short 2-3	Active NMI
Open	Disabled



● **JP14: Watchdog Timer Out Period Select**

Period	PINS 1-2	PINS 3-4	PINS 5-6	PINS 7-8
1 sec (default)	Open	Open	Short	Open
2 sec	Open	Open	Short	Short
10 sec	Open	Short	Open	Open
20 sec	Open	Short	Open	Short
110 sec	Short	Open	Open	Open
220 sec	Short	Open	Open	Short

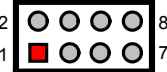

The watchdog timer is disabled after the system power-on. The watchdog timer can be enabled by a Enable cycle with reading the control port (443H), a Refresh cycle with reading the control port (443H) and a Disable cycle by reading the watchdog timer disable control port (043H). After a Enable cycle of WDT, user must constantly proceed a Refresh cycle to WDT before its period setting comes ending of every 1, 2, 10, 20, 110 or 220 seconds (Please reference to the selection table of JP14 for WDT Time Out period setting). If the Refresh cycle does not active before WDT period cycle, the onboard WDT architecture will issue a Reset or NMI cycle to the system. The watchdog timer controlled by two I/O ports.

443H	I/O Read	Enable/Refresh cycle
043H	I/O Read	Disable cycle

The following sample program shows how to Enable, Disable and Refresh the watchdog timer :

```

WDT_EN_RF      EQU    0433H
WDT_DIS        EQU    0043H

WT_Enable
    PUSH    AX                ; keep AX DX
    PUSH    DX
    MOV     DX,WDT_EN_RF    ; enable the WDT
    IN     AL,DX
    POP     DX                ; get back AX, DX
    POP     AX
    RET

```

```

WT_Refresh      PUSH    AX           ; keep AX, DX
                PUSH    DX
                MOV     DX,WDT_ET_RF ; refresh the WDT
                IN     AL,DX
                POP    DX           ; get back AX, DX
                POP    AX
                RET

WT_DISABLE      PUSH    AX
                PUSH    DX
                MOV     DX,WDT_DIS   ; disable the WDT
                IN     AL,DX
                POP    DX           ; get back AX, DX
                POP    AX
                RET

```

3.7 VGA Controller

The onboard C&T 65545 CRT/Panel display controller provides up to 1024 x 768 at 16 colors resolution. The HS-3000/4M provides two connection methods of CRT and Panel device. *CN18* offers a 15-pin CRT connector, and *CN11* offers a 50-pin Panel connector.

- **CN18: CRT Connector (8x2 header)**

PIN	Description	PIN	Description
1	RED	2	GREEN
3	BLUE	4	N/C
5	GND	6	GND
7	GND	8	GND
9	N/C	10	GND
11	N/C	12	N/C
13	HSYNC	14	VSYNC
15	N/C		

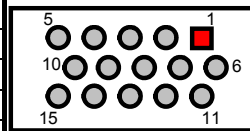

The HS-3000/4M provides a 44-pin 2.0mm pitch header connector (*CN11*).

- **CN11: Panel Connector**

CN11	Description	CN11	Description
1	+12V	2	+12V
3	GND	4	GND
5	PVcc	6	PVcc
7	FPVee	8	GND
9	P ₀	10	P ₁
11	P ₂	12	P ₃

...More on next page...

CN11	Description	CN11	Description
13	P ₄	14	P ₅
15	P ₆	16	P ₇
17	P ₈	18	P ₉
19	P ₁₀	20	P ₁₁
21	P ₁₂	22	P ₁₃
23	P ₁₄	24	P ₁₅
25	P ₁₆	26	P ₁₇
27	P ₁₈	28	P ₁₉
29	P ₂₀	30	P ₂₁
31	P ₂₂	32	P ₂₃
33	GND	34	GND
35	SHFCLK	36	FLM
37	M	38	LP
39	GND	40	ENABKL
41	GND	42	ASHFCLK
43	VCC	44	VCC

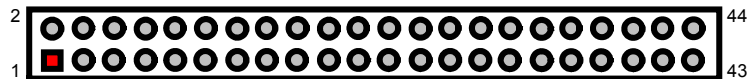

3.7.1 Connectors for Standard LCDs

● Sharp LM64183P (640 x 480 DSTN MONO LCD)

Sharp LM64P83(CN1)		HS-3000/4M(CN11)	
PIN	Description	PIN	Description
1	S	36	FLM
2	CP1	38	LP
3	CP2	35	SHFCLK
4	DISP	5	+5V
5	VDD	6	+5V
6	VSS	3	GND
7	VEE	-	-17V (external power)
8	DU0	12	P3
9	DU1	11	P2
10	DU2	10	P1
11	DU3	9	P0
12	DL0	16	P7
13	DL1	15	P6
14	DL2	14	P5
15	DL3	13	P4

● Sharp LM64C35P (640 x 480 DSTN STN Color)

Sharp LM64C35P(CN1)		HS-3000/4M(CN11)	
PIN	Description	PIN	Description
1	DL4	16	P7
2	VSS	3	GND
3	DL5	15	P6
4	TD	36	FLM
5	DL6	14	P5
6	LP	38	LP
7	DL7	13	P4
8	VSS	4	GND
9	VSS	8	GND
10	XCK	35	SLFCHK
11	DL0	24	P15
12	VCON	-	Contrast Adjust
13	DL1	23	P14
14	VDD	5	+5V
15	VSS	33	GND
16	VDD	6	+5V
17	DL2	22	P13
18	DISP	6	+5V
19	DL3	21	P12
20	N/C	-	-
21	VSS	34	GND
22	DU3	17	P8
23	DU4	12	P3
24	DU2	18	P9
25	DU5	11	P2
26	DU1	19	P10
27	VSS	39	GND
28	DU0	20	P11
29	DU6	10	P1
30	VSS	39	GND
31	DU7	9	P0

● **Sharp LM64C142(640 x 480 DSTN STN Color)**

Sharp LM64C142(CN1)		HS-3000/4M(CN11)	
PIN	Description	PIN	Description
1	YD	36	FLM
2	LP	38	LP
3	XCX	35	SHFCLK
4	DISP	5	+5V
5	PVDD	6	+5V
6	PVSS	3	GND
7	PVEE	-	+27V (external power)
8	DU0	20	P11
9	DU1	19	P10
10	DU2	18	P9
11	DU3	17	P8
12	DU4	12	P3
13	DU5	11	P2
14	DU6	10	P1
15	DU7	9	P0

Sharp LM64C142 (CN2)		HS-3000/4M(CN11)	
PIN	Description	PIN	Description
1	VSS	4	GND
2	DL0	24	P15
3	DL1	23	P14
4	DL2	22	P13
5	DL3	21	P12
6	DL4	16	P7
7	DL5	15	P6
8	DL6	14	P5
9	DL7	13	P4
10	VSS	8	GND

● **NEC NL8060AC26 (800 x 600 TFT Color)**

NEC NL8060AC26(CN1)		HS-3000/4M(CN11)	
PIN	Description	PIN	Description
1	GND	3	GND
2	Dot Clock	35	SHFCLK
3	GND	4	GND
4	HSYNC	38	LP
5	HSYNC	38	FLM
6	GND	8	GND
7	GND	8	GND

...More on next page...

NEC NL8060AC26(CN1)		HS-3000/4M(CN11)	
PIN	Description	PIN	Description
8	GND	8	GND
9	R0	27	P18
10	R1	28	P19
11	R2	29	P20
12	GND	8	GND
13	R3	30	P21
14	R4	31	P22
15	R5	32	P23
16	GND	39	GND
17	GND	39	GND
18	GND	39	GND
19	G0	19	P10
20	G1	20	P11
21	G2	21	P12
22	GND	39	GND
23	G3	22	P13
24	G4	23	P14
25	G5	24	P15
26	GND	41	GND
27	GND	41	GND
28	GND	41	GND
29	B0	11	P2
30	B1	12	P3
31	B2	13	P4
32	GND	41	GND
33	B3	14	P5
34	B4	15	P6
35	B5	16	P7
36	GND	41	GND
37	DE	37	M
38	PVCC	43	PVCC
39	PVCC	44	PVCC
40	PVCC	5	PVCC
41	MODE	-	---

3.8 Serial Port Connectors

The HS-3000/4M's CN17, 14, 15 and 16 provide four high speeds NS16C550 compatible USRT with Read/Receive 16 byte FIFO serial ports.

- **CN14, 15, 16: COM 2~COM 4 Connector (5x2 header)**

PIN	Description	PIN	Description
1	DCD	2	DSR
3	RXD	4	RTX
5	TXD	6	CTX
7	DTR	8	RI
9	GND	10	N/C

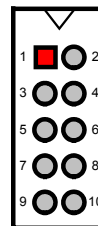

- **CN17: COM 1 Connector (DB9)**

PIN	Description	PIN	Description
1	DCD	6	DSR
2	RXD	7	RTS
3	TXD	8	CTS
4	DTR	9	RI
5	GND		

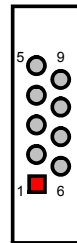

- **JP1: COM 4 Use RS-232 or RS-422/485 Select**

JP1	Description
Short	RS-232
Open (default)	RS-422/485



- **CN12: RS-422/485 Connector (5x2 header)**

PIN	Description	PIN	Description
1	TX-	2	TX+
3	RX+	4	RX-
5	GND	6	RTS-
7	RTS+	8	CTS+
9	CTS-	10	N/C

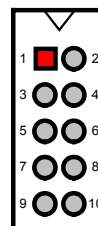

- **JP12: RS-422/485 Receiver Enabled/Disabled Select**

JP12	Description
Short 1-2 (default)	Always Enable
Short 3-4	Enable by writing the REG.2EFh BIT1=1
All Open	Always Disable

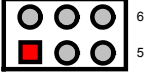

- **JP13: RS-422/485 Transceiver Enabled/Disabled Select**

JP13	Description
Short 1-2 (default)	Always Enable
Short 3-4	Enable by "-RTS" signal
Short 5-6	Enable by writing the REG.2EFh BIT0=1
Short 7-8	Always Disable

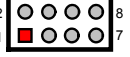

3.9 Keyboard & Mouse Connector

The HS-3000/4M offers two connection methods for keyboard connector, at location CN19 is 5-pin connector, location CN21 is PS/2 6-pin Mini DIN connector.

- **CN19: 5-pin Keyboard Connector**

PIN	Description
1	Keyboard Clock
2	Keyboard Data
3	N/C
4	GND
5	+5V



- **CN21: PS/2 6-pin Mini DIN Keyboard Connector**

PIN	Description
1	Keyboard Data
2	N/C
3	GND
4	+5V
5	Keyboard Clock
6	N/C

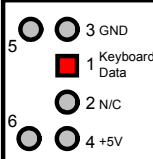

The HS-3000/4M has a PS/2 mouse connector onboard uses IRQ12. If you do not use the PS/2 mouse and wish to assign IRQ12 for other purposes, you may change JP8 do disconnect PS/2 interrupt from IRQ12.

- **JP8: IRQ12 Enabled/Disabled Select**

JP8	Description
Open	Disabled
Short (default)	Enabled



NOTE: If you want to use PS/2 mouse, please make sure JP8 is Short.

- **CN20: PS/2 6-pin Mini DIN Mouse Connector**

PIN	Description
1	Mouse Data
2	N/C
3	GND
4	+5V
5	Mouse Clock
6	N/C

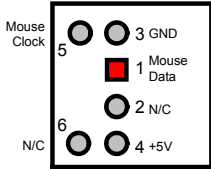

3.10 Speaker Connector

The HS-3000/4M has its own buzzer, and CN5 allows user to connect to the external speaker.

- **CN5: Speaker Connector**

PIN	Description
1	Speaker
2	N/C
3	GND
4	+5V

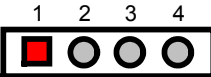

3.11 PCI E-IDE Drive Connector

One standard 40-pin header daisy-chain driver connector provides as *CN10* with following pin assignment. Total two IDE (Integrated Device Electronics) drivers may connect.

- **CN10: IDE Connector**

PIN	Description	PIN	Description
1	Reset	2	GND
3	DATA 7	4	DATA 8
5	DATA 6	6	DATA 9
7	DATA 5	8	DATA 10
9	DATA 4	10	DATA 11
11	DATA 3	12	DATA 12
13	DATA 2	14	DATA 13
15	DATA 1	16	DATA 14
17	DATA 0	18	DATA 15
19	GND	20	N/C
21	N/C	22	GND
23	IOW#	24	GND
25	IOR#	26	GND
27	N/C	28	Bale – Default
29	N/C	30	GND - Default
31	Interrupt	32	IOCS16# - Default
33	SA1	34	N/C
35	SA0	36	SA2
37	HDC CS0	38	HDC CS1#
39	HDD Active	40	GND

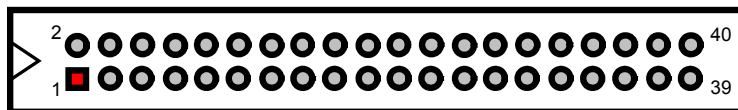

3.12 Parallel Connector

A standard 26-pin flat cable driver connector provides as CN2 with following pin assignment for connection to parallel printer.

- **CN2: Parallel Connector**

PIN	Description	PIN	Description
1	STROBE	14	Auto Form Feed
2	DATA 0	15	ERROR#
3	DATA 1	16	Initialize
4	DATA 2	17	Printer Select LN#
5	DATA 3	18	GND
6	DATA 4	19	GND
7	DATA 5	20	GND
8	DATA 6	21	GND
9	DATA 7	22	GND
10	Acknowledge	23	GND
11	Busy	24	GND
12	Paper Empty	25	GND
13	Printer Select	26	GND

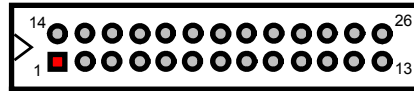

3.13 Power and LED Connectors

The following provides the pin information for CN1 4-pin power connector, CN3 reset button connector, CN4 power LED and keylock connector, and CN6 is IDE LED.

- **CN1: 4-pin Power Connector**

PIN	Description
1	VCC
2	GND
3	GND
4	+12V

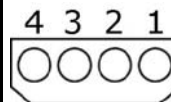

- **CN3: Reset Button Connector**

PIN	Description
1	Reset Signal
2	GND



- **CN4: Keylock and Power LED Connector**

PIN	Description
1	Power LED
2	N/C
3	GND
4	Keylock
5	GND

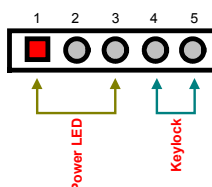

- **CN6: IDE LED Connector**

PIN	Description
1	VCC
2	HDD Active



3.14 Floppy Disk Drive Connector

The HS-3000/4M uses a standard 34-pin header connector, *CN7*, for floppy disk drive connection. A total of two FDD drives may be connected at any given time.

- **CN7: Floppy Connector**

PIN	Description	PIN	Description
1	GND	2	Reduce Write
3	GND	4	N/C
5	GND	6	N/C
7	GND	8	Index#
9	GND	10	MTR0#
11	GND	12	DS1#
13	GND	14	DS0#
15	GND	16	MTR1#
17	GND	18	Direction#
19	GND	20	Step#
21	GND	22	Write Data#
23	GND	24	Write Gate#
25	GND	26	Track 0#
27	GND	28	Write Protect#
29	N/C	30	Read Data#
31	GND	32	HDSEL#
33	N/C	34	Disk Change#

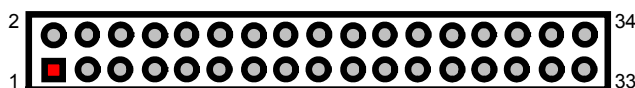

3.15 Flash ROM Type

The JP15 provides in selection the type of Flash ROM type. If VPP is +5V please set 29C010, VPP is +12V please set 28F010.

- **JP15: Flash ROM Type Select**

Options	Setting
29C010 (default)	Short 1-2
28F010	Short 2-3



3.16 System Memory

The HS-3000/4M has one SIMM socket, provides 72-pin SIMM module. The memory access time should be 70ns or less. The HS-3000/4M has one SIM socket and 4MB RAM onboard.

- **Memory Type Configuration**

SM1	SM2		
	BANK0	BANK1	Total
4MB RAM Onboard	256K x 2	256K x 2	1M
	512K x 2	----	1M
	512K x 2	512K x 2	2M
	512K x 2	1M x 2	3M
	512K x 2	4M x 2	9M
	1M x 2	----	2M
	1M x 2	1M x 2	4M
	1M x 2	4M x 2	10M
	2M x 2	----	4M
	2M x 2	2M x 2	8M
	2M x 2	4M x 2	12M
	4M x 2	----	8M
	4M x 2	4M x 2	16M

3.17 PC/104 Bus Connection

The PC/104 expansion bus offers provisions to connect all types of PC/104 modules. With the PC/104 bus being known as the new generation of industrial embedded 16-bit PC standard bus, thousands of PC/104 modules from multiple vendors can be easily installed onboard. The detailed pin assignment of the PC/104 expansion bus connectors CN8 and CN9 are listed on the following tables.

NOTE : *The PC/104 connector allows direct plugging or stack-through piling of PC/104 modules without requiring the PC/104 mounting kit.*

● **CN8: PC/104 64-pin Connector**

PIN	Description	PIN	Description
1	IOCHECK*	33	GND
2	SD7	34	RESETDRV
3	SD6	35	+5V
4	SD5	36	IRQ9
5	SD4	37	-5V
6	SD3	38	DRQ2
7	SD2	39	-12V
8	SD1	40	NOW*
9	SD0	41	+12V
10	IOCHRDY	42	GND
11	AEN	43	SMEMW*
12	SA19	44	SMEMR*
13	SA18	45	IOW*
14	SA17	46	IOR*
15	SA16	47	DACK3*
16	SA15	48	DRQ3
17	SA14	49	DACK1*
18	SA13	50	DRQ1
19	SA12	51	REFRESH*
20	SA11	52	SYSCLK
21	SA10	53	IRQ7
22	SA9	54	IRQ6
23	SA8	55	IRQ5
24	SA7	56	IRQ4
25	SA6	57	IRQ3
26	SA5	58	DACK2*
27	SA4	59	TC
28	SA3	60	BALE
29	SA2	61	+5V
30	SA1	62	OSC
31	SA0	63	GND
32	GND	64	GND

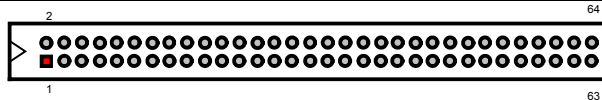

● **CN9: PC/104 40-pin Connector**

PIN	Description	PIN	Description
1	GND	21	GND
2	MEMCS16*	22	SBHE*
3	IOSC16*	23	LA23
4	IRQ10	24	LA22
5	IRQ11	25	LA21
6	MSDATA	26	LA20
7	IRQ15	27	LA19
8	IRQ14	28	LA18
9	DACK0*	29	LA17
10	DRQ0	30	MEMR*
11	DACK5*	31	MEMW*
12	DRQ5	32	SD8
13	DACK6*	33	SD9
14	DRQ6	34	SD10
15	DACK7*	35	SD11
16	DRQ7	36	SD12
17	+5V	37	SD13
18	MASTER*	38	SD14
19	GND	39	SD15
20	GND	40	N/C

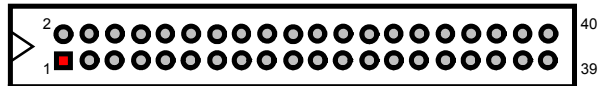

This page is intentionally left blank.

Chapter 4

AMI BIOS Setup

The HS-3200/4M uses Award ISA BIOS for the system configuration. The AMI BIOS setup program is designed to provide the maximum flexibility in configuring the system by offering various options that could be selected for end-user requirements. This chapter is written to assist you in the proper usage of these features.

4.1 Starting Setup

The Award BIOS is immediately activated when you first power on the computer. The BIOS reads the system information contained in the CMOS and begins the process of checking out the system and configuring it. When it finishes, the BIOS will seek an operating system on one of the disks and then launch and turn control over to the operating system.

While the BIOS is in control, the Setup program can be activated in one of two ways:

1. By pressing immediately after switching the system on,
or
2. By pressing the key when the following message appears briefly at the bottom of the screen during the POST (Power On Self Test).

Press DEL to enter SETUP.

If the message disappears before you respond and you still wish to enter Setup, restart the system to try again by turning it OFF then ON or pressing the "RESET" button on the system case. You may also restart by simultaneously pressing <Ctrl>, <Alt>, and <Delete> keys. If you do not press the keys at the correct time and the system does not boot, an error message will be displayed and you will again be asked to...

PRESS F1 TO CONTINUE, DEL TO ENTER SETUP

4.2 Using Setup

In general, you use the arrow keys to highlight items, press <Enter> to select, use the <PageUp> and <PageDown> keys to change entries, press <F1> for help and press <Esc> to quit. The following table provides more detail about how to navigate in the Setup program using the keyboard.

Up arrow	Move to previous item
Down arrow	Move to next item
Left arrow	Move to the item in the left hand
Right arrow	Move to the item in the right hand
Esc key	Main Menu -- Quit and not save changes into CMOS Status Page Setup Menu and Option Page Setup Menu -- Exit current page and return to Main Menu
PgUp key	Increase the numeric value or make changes
PgDn key	Decrease the numeric value or make changes
+ key	Increase the numeric value or make changes
- key	Decrease the numeric value or make changes
F1 key	General help, only for Status Page Setup Menu and Option Page Setup Menu
(Shift)F2 key	Change color from total 16 colors. F2 to select color forward, (Shift) F2 to select color backward
F3 key	Calendar, only for Status Page Setup Menu
F4 key	Reserved
F5 key	Restore the previous CMOS value from CMOS, only for Option Page Setup Menu
F6 key	Load the default CMOS value from BIOS default table, only for Option Page Setup Menu
F7 key	Load the default
F8 key	Reserved
F9 key	Reserved
F10 key	Save all the CMOS changes, only for Main Menu

4.2.1 Getting Help

Press F1 to pop up a small help window that describes the appropriate keys to use and the possible selections for the highlighted item. To exit the Help Window press <Esc> or the F1 key again.

4.3 Main Menu

Once you enter the Award BIOS CMOS Setup Utility, the Main Menu will appear on the screen. The Main Menu allows you to select from several setup functions and two exit choices. Use the arrow keys to select among the items and press <Enter> to enter the sub-menu.

AMI BIOS Setup Utility – Version 1.23 © 1999 American Megatrends, Inc. All Rights Reserved
STANDARD CMOS SETUP Advanced CMOS Setup Advanced Chipset Setup PCI / Plug and Play Setup Peripheral Setup Auto-Detect Hard Disks Change User Password Change Language Setting Auto Configuration with Optional Settings Auto Configuration with Fail Safe Settings Save Settings and Exit Exit Without Saving
Load configuration settings giving highest performance Esc: Exit ↑↓: Sel F2/F3: Color F10: Save & Exit

4.4 Standard CMOS Setup

The Standard Setup is used for the basic hardware system configuration. The main function is for Data/Time and Floppy/Hard Disk Drive settings. Please refer to the following screen for the setup. When the IDE hard disk drive you are using is larger than 528MB, please set the HDD mode to **LBA** mode. Please use the IDE Setup Utility in BIOS SETUP to install the HDD correctly.

AMI BIOS Setup – Standard CMOS Setup							
© 1999 American Megatrends, Inc. All Rights Reserved							
Data (mm:dd:yy) :	Fri, Dec 20 2002				Base Memory: 640 KB		
Time (hh:mm:ss) :	14 : 50 : 1				Ext Memory: 3 MB		
	Type	CYLS	HEAD	PRECOMP	LANDZ	SECTOR	MODE
Pri Master	: Auto						Off
Pri Slave	: Auto						Off
Floppy Drive A	: 1.44 MB 3.5						
Floppy Drive B	: Not Installed						
Boot Sector Virus Protection:	Disabled						
Month:	Jan – Dec			ESC: Quit ↑↓: Sel			
Day:	01 – 31			PgUp/PgDn: Modify			
Year:	1901 – 2099			F1: Help F2/F3: Color			

4.5 Advanced CMOS Setup

This section allows you to configure your system for the basic operation. You have the opportunity to select the system's default speed, boot-up sequence, keyboard operation, shadowing and security.

AMIBIOS SETUP – ADVANCED CMOS SETUP (C)2001 American Megatrends, Inc. All Rights Reserved		
Quick Boot	Disabled	Available Options:
1st Boot Device	IDE-0	▶ Disabled
2nd Boot Device	Floppy	Enabled
3rd Boot Device	Disabled	
Try Other Boot Devices	Yes	
BootUp Num-Lock	On	
Floppy Drive Swap	Disabled	
Floppy Drive Seek	Disabled	
PS/2 Mouse Support	Enabled	
System Keyboard	Present	
Primary Display	VGA/EGA	
Password Check	Setup	
Wait For 'F1' If Error	Enabled	
C000, 32k Shadow	Disabled	
C800, 32k Shadow	Disabled	
D000, 32k Shadow	Disabled	
D800, 32k Shadow	Disabled	
		ESC:Exit ↑↓:Sel
		PgUp/PgDn: Modify
		F1:Help F2/F3:Color

4.6 Advanced Chipset Setup

This section allows you to configure the system based on the specific features of the installed chipset. This chipset manages bus speeds and the access to the system memory resources, such as DRAM and the external cache. It also coordinates the communications between the conventional ISA and PCI buses. It must be stated that these items should never be altered. The default settings have been chosen because they provide the best operating conditions for your system. You might consider and make any changes only if you discover that the data has been lost while using your system.

AMIBIOS SETUP – ADVANCED CHIPSET SETUP (C)1999 American Megatrends, Inc. All Rights Reserved		
AT Bus Clock	14.318/2	Available Options: ▶ Disabled Enabled ESC:Exit ↑↓:Sel PgUp/PgDn: Modify F1:Help F2/F3:Color
Slow Refresh (us)	120	
Memory Hole At 15-16M	Disabled	
RAS Precharge time	3.5T	
RAS Active Time Insert Wait	Enabled	
CAS Precharge Time Insert Wait	Enabled	
Memory Write Insert Wait	Enabled	
Memory Miss Read Insert Wait	Enabled	
ISA Write cycle end Insert Wait	Enabled	
I/O Recovery	Enabled	
I/O Recovery Period	0.75 us	
On-Chip I/O Recovery	Disabled	
16Bit ISA Insert Wait	Enabled	

4.7 PCI / Plug And Play Setup

This section describes configuring the PCI bus system. PCI, or **Personal Computer Interconnect**, is a system that allows I/O devices to operate at speeds nearing the speed the CPU itself uses when communicating with its own special components. This section covers some very technical items and it is strongly recommended that only experienced users should make any changes to the default settings.

AMIBIOS SETUP – PCI / PLUG AND PLAY SETUP (C)1999 American Megatrends, Inc. All Rights Reserved		
Plug and Play Aware O/S	No	Available Options:
DMA Channel 0	PnP	► No
DMA Channel 1	PnP	Yes
DMA Channel 3	PnP	
DMA Channel 5	PnP	
DMA Channel 6	PnP	
DMA Channel 7	PnP	
IRQ3	PnP	
IRQ4	PnP	
IRQ7	PnP	
IRQ9	PnP	
IRQ10	PnP	
IRQ11	PnP	ESC:Exit ↑↓:Sel
IRQ14	PnP	PgUp/PgDn: Modify
IRQ15	PnP	F1:Help F2/F3:Color

4.8 Peripheral Setup

The IDE hard drive controllers can support up to two separate hard drives. These drives have a master/slave relationship that is determined by the cabling configuration used to attach them to the controller. Your system supports two IDE controllers--a primary and a secondary--so you can install up to four separate hard disks.

PIO means Programmed Input/Output. Rather than having the BIOS issue a series of commands to affect the transfer to or from the disk drive, PIO allows the BIOS to tell the controller what it wants and then let the controller and the CPU perform the complete task by them. This is much simpler and more efficient (also faster).

AMIBIOS SETUP – PERIPHERAL SETUP (C)1999 American Megatrends, Inc. All Rights Reserved		
OnBoard IDE	Primary	Available Options: ▶ Disabled
OnBoard FDC	Auto	
OnBoard Serial Port 1	Auto	Primary
OnBoard Serial Port 2	Auto	Secondary
Serial Port2 Mode	Normal	Both
Receiver Polarity	Non-Inverted	
Transmitter Polarity	Non-Inverted	
OnBoard Serial Port3	Auto	
Serial Port3 IRQ	Auto	
OnBoard Serial Port4	Auto	
Serial Port4 Mode	Normal	
Serial Port4 IRQ	Auto	
Receiver Polarity	Non-Inverted	
Transmitter Polarity	Non-Inverted	
OnBoard Parallel Port	Auto	
Parallel Port Mode	ECP	
EPP Version	N/A	
Parallel Port IRQ	Auto	
Parallel Port DMA Channel	Auto	
		ESC:Exit ↑↓:Sel
		PgUp/PgDn: Modify
		F1:Help F2/F3:Color

4.9 Auto-Detect Hard Disks

This option detects the parameters of an IDE hard disk drive, and automatically enters them into the Standard CMOS Setup screen.

Up to four IDE drives can be detected, with parameters for each appearing in sequence inside a box. To accept the displayed entries, press the “Y” key; to skip to the next drive, press the “N” key. If you accept the values, the parameters will appear listed beside the drive letter on the screen.

AMIBIOS SETUP – PERIPHERAL SETUP (C)1999 American Megatrends, Inc. All Rights Reserved
Standard CMOS Setup Advanced CMOS Setup Advanced Chipset Setup Power Management Setup PCI / Plug and Play Setup Peripheral Setup Hardware Monitor Setup <u>Auto-Detect Hard Disks</u> Change User Password Change Supervisor Password Auto Configuration with Optimal Settings Auto Configuration with Fail Safe Settings Save Settings and Exit Exit Without Saving
Standard CMOS setup for changing time, date, hard disk type, etc. ESC:Exit ↑↓:Sel F2/F3: Color F10: Save & Exit

4.10 Change Supervisor/User Password

<p>AMIBIOS SETUP – PERIPHERAL SETUP (C)1999 American Megatrends, Inc. All Rights Reserved</p>
<p>Standard CMOS Setup Advanced CMOS Setup Advanced Chipset Setup Power Management Setup</p>
<p>Enter new supervisor password: _</p>
<p>Change Supervisor Password Auto Configuration with Optimal Settings Auto Configuration with Fail Safe Settings Save Settings and Exit Exit Without Saving</p>
<p>Standard CMOS setup for changing time, date, hard disk type, etc. ESC:Exit ↑↓:Sel F2/F3: Color F10: Save & Exit</p>

You can set either supervisor or user password, or both of them. The differences between are:

- **supervisor password:** can enter and change the options of the setup menus.
- **user password:** just can only enter but do not have the right to change the options of the setup menus.

When you select this function, the following message will appear at the center of the screen to assist you in creating a password.

ENTER PASSWORD:

Type the password, up to eight characters in length, and press <Enter>. The password typed now will clear any previously entered password from CMOS memory. You will be asked to confirm the password. Type the password again and press <Enter>. You may also press <Esc> to abort the selection and not enter a password.

To disable a password, just press <Enter> when you are prompted to enter the password. A message will confirm the password will be disabled. Once the password is disabled, the system will boot and you can enter Setup freely.

PASSWORD DISABLED.

When a password has been enabled, you will be prompted to enter it every time you try to enter Setup. This prevents an unauthorized

person from changing any part of your system configuration.

Additionally, when a password is enabled, you can also require the BIOS to request a password every time your system is rebooted. This would prevent unauthorized use of your computer.

You determine when the password is required within the BIOS Features Setup Menu and its Security option (see Section 3). If the Security option is set to "System", the password will be required both at boot and at entry to Setup. If set to "Setup", prompting only occurs when trying to enter Setup.

4.11 Auto Configuration with Optimal Settings

When you press <Enter> on this item you will get a confirmation dialog box with a message shown below. This option allows you to load/restore the BIOS default values permanently stored in the BIOS ROM. Pressing 'Y' loads the BIOS default values for the most stable, minimal-performance system operations.

<p>AMIBIOS SETUP – PERIPHERAL SETUP (C)1999 American Megatrends, Inc. All Rights Reserved</p>
<p>Standard CMOS Setup Advanced CMOS Setup Advanced Chipset Setup Power Management Setup</p>
<p>Load high performance settings (Y/N) ? <u>N</u></p>
<p>Change Supervisor Password Auto Configuration with Optimal Settings Auto Configuration with Fail Safe Settings Save Settings and Exit Exit Without Saving</p>
<p>Standard CMOS setup for changing time, date, hard disk type, etc. ESC:Exit ↑↓:Sel F2/F3: Color F10: Save & Exit</p>

4.12 Auto Configuration with Fail Safe Settings

When you press <Enter> on this item you get a confirmation dialog box with a message similar to the figure below. This option allows you to load/restore the default values to your system configuration, optimizing and enabling all high performance features. Pressing 'Y' loads the default values that are factory settings for optimal performance system operations.

AMIBIOS SETUP – PERIPHERAL SETUP (C)1999 American Megatrends, Inc. All Rights Reserved
Standard CMOS Setup Advanced CMOS Setup Advanced Chipset Setup Power Management Setup
Load failsafe settings (Y/N) ? <u>N</u>
Change Supervisor Password Auto Configuration with Optimal Settings Auto Configuration with Fail Safe Settings Save Settings and Exit Exit Without Saving
Standard CMOS setup for changing time, date, hard disk type, etc. ESC:Exit ↑↓:Sel F2/F3: Color F10: Save & Exit

4.13 Save Settings and Exit

Pressing <Enter> on this item asks for confirmation:

AMIBIOS SETUP – PERIPHERAL SETUP (C)1999 American Megatrends, Inc. All Rights Reserved
Standard CMOS Setup Advanced CMOS Setup Advanced Chipset Setup Power Management Setup
Save current settings and exit (Y/N) ? <u>Y</u>
Change Supervisor Password Auto Configuration with Optimal Settings Auto Configuration with Fail Safe Settings Save Settings and Exit Exit Without Saving
Standard CMOS setup for changing time, date, hard disk type, etc. ESC:Exit ↑↓:Sel F2/F3: Color F10: Save & Exit

Pressing “Y” stores the selections made in the menus in CMOS – a special section of memory that stays on after you turn your system off. The next time you boot your computer, the BIOS configures your system according to the Setup selections stored in CMOS. After saving the values the system is restarted again.

4.14 Exit Without Saving

Pressing <Enter> on this item asks for confirmation:

Quit without saving (Y/N)? Y

This allows you to exit Setup without storing in CMOS any change. The previous selections remain in effect. This exits the Setup utility and restarts your computer.

<p>AMIBIOS SETUP – PERIPHERAL SETUP (C)1999 American Megatrends, Inc. All Rights Reserved</p>
<p>Standard CMOS Setup Advanced CMOS Setup Advanced Chipset Setup Power Management Setup</p>
<p>Quit without saving (Y/N) ? <u>N</u></p>
<p>Change Supervisor Password Auto Configuration with Optimal Settings Auto Configuration with Fail Safe Settings Save Settings and Exit Exit Without Saving</p>
<p>Standard CMOS setup for changing time, date, hard disk type, etc. ESC:Exit ↑↓:Sel F2/F3: Color F10: Save & Exit</p>
<p>Abandon all Data & Exit Setup</p>